



PROCEDURE



Title: **Work at Height**

Procedure No: P314.311	Issue: 5	Revision: 4	Operative Date: 16/10/2015	Author: M Simons
Department: HSEC	Sect./Classification: Safety	Category: Work Areas	Owner Role: Specialist - Safety	Approver Role: Manager - Health & Safety
				Appr. Signature:

CONTENTS

1.0	PURPOSE	1
2.0	SCOPE	1
3.0	RESPONSIBILITIES	1
4.0	REFERENCES	2
5.0	DEFINITIONS	2
6.0	ACTIONS	5
6.1	Risk Management Before Work Starts	5
6.2	Control Measures for Risk of an Object Falling	5
6.3	Control Measures for Risk of a Person Falling	6
6.4	Elevating Work Platforms	11
6.5	Scissor Lift	12
6.6	Workbox	12
6.7	Scaffolding	12
6.8	Ladders	13
6.9	Inspections	13
6.10	Approval of Alternative Methods	13
6.11	Training	14
6.12	Records	14
7.0	ATTACHMENTS	14

1.0 PURPOSE

To provide minimum standards for work at height

As a principle:

No person, as a result of work at height, shall be exposed to the risk of being hit by a falling object.

No person shall be exposed to the risk of a fall that is likely to cause injury

2.0 SCOPE

2.1 The requirements of this procedure are mandatory for all work on the QAL site involving QAL employees and contractors.

2.2 The requirements of this procedure shall also be followed during transit to a work at height location, where the transit route qualifies as work at height location

3.0 RESPONSIBILITIES

Section Superintendent/Contractor Principal

Ensure all persons using personal fall protection systems are trained in the safe and correct use of that system including initiating a rescue plan after a worker has fallen.

FORM NO: QA-053-0215	IF THIS DOCUMENT IS IN PRINTED FORMAT, AND NOT CONTAINED IN A CONTROLLED MANUAL, THIS IS <u>NOT</u> A CONTROLLED QUALITY SYSTEM DOCUMENT	PAGE 1 of 14
-------------------------	--	-----------------

Title: Work at Height	No: P314.311 Issue: 5 Rev: 3	Approval: (Inits)
------------------------------	--	----------------------

Ensure that inspections of all components of a personal fall protection system are conducted as per Section 6.9.

Competent Person

Perform pre-inspection maintenance and equipment inspections as per Section 6.9.

Supervisor

Ensure that the potential of an object or person to fall is managed as per this procedure.

Ensure there is a written rescue plan and equipment available for the safe retrieval of a person who has fallen.

Ensure that the user of a fall arrest system does not work alone.

Ensure industrial safety nets are managed appropriately.

User of Personal Fall Protection Systems

Inspect harnesses and lanyard assemblies prior to every use.

Ensure that the fall-arrest / travel restrain system is used properly taking into account fall clearance etc

4.0 REFERENCES

- P312.402 – Pre-Task Hazard Assessment
- P314.301 – Barricades and Cordons
- P314.316 – Permit to Remove Flooring, Handrails or Edge Protection
- P314.401 – Portable Ladders
- P314.402 – Scaffolding, Temporary Work Platforms and Suspended Scaffolds
- P314.414 – Cranes and Lifting
- P703.010 – Audit Requirements
- Engineering Standard QD50-042-02 Access Guide for Access Hatches, Manways and Inspection Ports
- Engineering Standard QM50-131-02 Synthetic Slings and Safety Harnesses
- Engineering Standard QM50-137-02 Temporary Static Safety Lines
- Rio Tinto Safety Standard C4 Working at Heights
- Work Health and Safety Act
- Work Health and Safety Regulation
- Managing the Risk of Falls at Workplaces Code of Practice
- AS1418.10 Cranes, Hoists and Winches – Mobile Elevating Work Platforms
- AS1891.1 Industrial Fall Arrest Systems and Devices – Harnesses and Ancillary Equipment
- AS1891.2 Industrial Fall Arrest Systems and Devices – Horizontal Lifeline and Rail Systems
- AS1891.3 Industrial Fall Arrest Systems and Devices – Fall Arrest Devices
- AS1891.4 Industrial Fall Arrest Systems – Selection Use and Maintenance
- AS/NZS 1576.1 Scaffolding – General Requirements
- AS/NZS 2550.1 Cranes, Hoists and Winches – Safe Use – General Requirements
- AS/NZS 2550.10 Cranes, Hoists and Winches – Safe Use Mobile Elevating Work Platforms
- AS/NZS 2626 Safety Belts and Harnesses – Selection, Use and Maintenance
- AS/NZS 4488.1 Industrial Rope Access Systems – Specifications
- AS/NZS 4488.2 Industrial Rope Access Systems – Selection, Use and Maintenance
- AS/NZS 4576.1 Guidelines for Scaffolding
- BS EN 360 Personal Protective Equipment Against Falls From Height – Retractor Type Fall Arrestors
- SM145 – Fatality Prevention for Field-based Employees
- Nationally Accredited Work Safety at Height course codes RIIOHS204A, MNMG237A, CPCCCM2010A or CPCCCM1006A
- Induction

5.0 DEFINITIONS

Anchorage Point – a secure point for attaching a lanyard, lifeline or other component of a travel restraint system or fall-arrest system. Anchorages require specific load and impact capacities for their intended use.

Barricade (Edge Protection) – a barrier to prevent access to a work area or to prevent a person falling which has been erected along the edge or an opening in the surface of a building or other structure or from

FORM NO: QA-053-0215	IF THIS DOCUMENT IS IN PRINTED FORMAT, AND NOT CONTAINED IN A CONTROLLED MANUAL, THIS IS <u>NOT</u> A CONTROLLED QUALITY SYSTEM DOCUMENT	PAGE 2 of 14
-------------------------	--	-----------------

Title: Work at Height	No: P314.311 Issue: 5 Rev: 3	Approval: (Inits)
------------------------------	--	----------------------

the surface from which work is to be done and is adequately fixed and capable of withstanding the weight of a person falling against or leaning on it. Examples are:

- Clamped or secured scaffold tubes
- Structural mesh or members which have been welded, nailed, securely tied or clamped
- Wire rope slings which have been shackled or secured to fixed supports/posts
- Plastic barricading mesh (fluorescent red/orange) firmly attached to fixed supports/posts

Catch / Overhead Platform – a platform designed to provided overhead protection to persons by catching falling objects.

Competent Person – a person who has acquired, through training, qualifications or experience **and** has been assessed to have the knowledge and skill to do the task in a safe way.

Cordons provide warning of a hazard but are of little or no structural significance and shall not be used to protect people falling from height, including when walkway floor plate / mesh, guard rails, or piping and plant are removed creating an opening. Examples of, but not limited to, are:

- Tapes
- Plastic barricade mesh (fluorescent red/orange) attached to portable stands
- Rope attached to stands which are free standing and unattached
- Bunting/ropes with flags

Elevating Work Platform – a telescoping device, scissor device or articulating device or any combination thereof used to position personnel, equipment and materials at work locations and to provide a working area for persons elevated by and working from the platform.

Fall-arrest Harness System – a system designed to arrest the fall of a person using it and to prevent or minimise the risk or injury to the person as the fall is arrested. It consists of a harness attached to a lanyard or line that has a device to absorb the energy of the person falling and is attached to a static line or anchorage point.

Free-fall – for a fall-arrest harness system, this means a vertical fall before the system starts to take load and is more than 600 mm but not more than 2 metres.

Fall-Arrest Harness – an assembly of interconnected shoulder and leg straps, with or without a body belt, designed to spread the load over the body and to prevent the wearer from falling out of the assembly. May also be referred to as a full body harness.

Fall Arresting Platform – a platform installed to arrest the fall of a person.

Fall Protection Cover - a structure that:

- is placed over an opening in a surface of a building or other structure to prevent a person falling through the opening; and
- consists of solid sheets of sturdy material, for example, timber, plywood, metal or mesh.

Gantry (Hoarding) – a structure that has an overhead platform and a hoarding at least 1800 mm high that is fully sheeted with timber, plywood, metal or sturdy synthetic sheets running along its length.

Inertia Reel – a type 2 or 3 fall-arrest device that arrests a fall by locking onto a line and at the same time allows freedom of movement, also known as a self-retracting lanyard or fall-arrest block.

PTHA – Pre-Task Hazard Assessment

Lanyard - an assembly consisting of a line and components which will enable connections between a harness and an anchorage point and will absorb energy in the event of a fall. A tool lanyard is a line to connect a tool to a person, structure or static line to eliminate the potential for the tool to fall.

Limited Free-Fall - for a fall-arrest harness system, means a vertical fall before the system starts to take load and is not more than 600 mm.

FORM NO: QA-053-0215	IF THIS DOCUMENT IS IN PRINTED FORMAT, AND NOT CONTAINED IN A CONTROLLED MANUAL, THIS IS <u>NOT</u> A CONTROLLED QUALITY SYSTEM DOCUMENT	PAGE 3 of 14
-------------------------	--	-----------------

Title: Work at Height	No: P314.311 Issue: 5 Rev: 3	Approval: (Inits)
------------------------------	--	----------------------

Perimeter Containment Screening – a screen designed to stop objects falling on persons from a level of a building or to redirect a falling object onto a catch platform.

Personal Energy Absorber – a device which reduces the deceleration force imposed when a fall is suddenly arrested, and correspondingly reduces the loadings on the anchorage and the person's body. The energy absorber may be a separate item or manufactured into the lanyard.

Rescue Plan – a documented list of steps on how to initiate a rescue response in the event of a fall. Depending on the risk assessment, this may include steps on how to initiate the rescue until the First Response Team arrives. (HSE-025 Rescue Plan for People Using Fall Arrest Harness System)

Restraint Belt - a body belt designed for attachment to a restraint line and not designed for either free or restrained fall.

Rope Grab, Backup Type – A manufactured device which is designed to slide along a safety line and whose purpose is to arrest a limited free fall.

Safety Line – a line used as a backup to arrest a limited free fall in the event of failure of the working line or its attachments.

Scissor Lift – a compact self-propelled mobile scaffold capable of moving in an extended state

Static Line – means a flexible line to which a lanyard is attached and is supported by at least 2 anchorage points located so that the angle between the horizontal and an imaginary straight line between any anchorage point and the other or nearest anchorage point is –

- not more than the size specified by the manufacturer of the flexible line, or
- not more than 5° if the manufacturer has not specified the size of the angle

Supervision

Supervision is a generic term used to describe people who control work processes. This term covers titles such as, Team Leader, In Charge Person, Red Tagger, Leading Hand, Supervisor, Acting Supervisor, Foreman, Co-Coordinator, Responsible Person or Mentor.

Suspended Load – A load suspended by lifting equipment and not fully supported by a structure or stand from below or fixed into position eg. welded or bolted.

Toe Board for a surface means an upright timber or metal board securely fixed in place at an edge of the surface.

Total Fall Distance - the total distance a person is likely to fall during both the free and restrained parts of a fall, including the maximum dynamic extension of all supporting components.

Travel Restraint System (Fall Prevention System) – means a system that consists of a harness, attached to one or more lanyards, each of which is attached to a static line or anchorage point. It is designed to restrict the travelling range of a person wearing the harness so the person cannot fall off an edge **or** through a surface.

Work at Height – Work at height includes work being performed in a situation where there is potential for a person or an object, including equipment, material, tools and debris, to fall or be emitted sideways or upwards or otherwise hit persons during work from a scaffold, permanent work platform, through a ceiling or floor and the like. Examples are hosing material from elevated structures, opening drain valves that discharge at height, tools falling off a working platform, rock and soil falling into a trench and falling material deflected off the side of a building.

Work at height can either be external, performed outside of any confining structure, or internal where work is performed above or inside a confining structure (eg tank, boiler internal etc), that has access holes or openings below or above allowing any falling object to enter or exit the work area.

FORM NO: QA-053-0215	IF THIS DOCUMENT IS IN PRINTED FORMAT, AND NOT CONTAINED IN A CONTROLLED MANUAL, THIS IS <u>NOT</u> A CONTROLLED QUALITY SYSTEM DOCUMENT	PAGE 4 of 14
-------------------------	--	-----------------

Title: Work at Height	No: P314.311 Issue: 5 Rev: 3	Approval: (Inits)
------------------------------	--	----------------------

Workbox – a personnel-carrying device, designed to be suspended from a crane, or attached to a forklift or similar, that provides a working area for persons elevated by and working from the box

6.0 ACTIONS

6.1 Risk Management Before Work Starts

Prior to starting any work at height, the person or workgroup involved in the task shall document the hazards in a Pretask Hazard Assessment to identify hazards that may result in a fall of an object or person and to identify control measures to minimise the risk.

If there is a risk of an object falling onto persons working below, then the flowchart in Attachment 7.1 shall be used to determine the appropriate controls. The control measures are discussed in Section 6.2.

If there is a risk of a person falling and the control measures involve a fall arrest harness system, then a rescue plan (Portal/Site Document Access/Forms/Health & Safety/HSE/HSE-025 Rescue Plan for People Using Fall Arrest Harness System) shall be completed. The control measures are discussed in Section 6.3.

If any flooring, handrails or edge protection is to be removed then a Permit is required from the Workplace Area Owner as per Procedure P314.316.

Scaffold erection and demolition techniques shall comply with AS/NZS 1576.1 Scaffolding – General Requirements.

If people have to access tank top rooves or building rooves the risk assessment must consider the physical integrity of the rooves.

6.2 Control Measures for Risk of an Object Falling

If there is a risk of an object falling on to persons working below then one of the following falling object risk management methods shall be implemented:

6.2.1 Work scheduling & planning

Time method – schedule work or otherwise managing work so that tasks creating an overhead work situation do not occur at the same time for different work groups.

Distance Method – planning or otherwise managing work so that tasks creating an overhead work situation do not occur in what is reasonably foreseeable and demarcated as the cordoned area.

6.2.2 Work group placement

Eliminating the risk by not having the workgroups work above and below each other.

Use of tool lanyards to prevent tools from falling.

Under no circumstances shall a person work under or be positioned under a suspended load.

6.2.3 Barricades & Cordons

Barricading or cordoning of the potential fall zone at lower levels shall be carried out as per Procedure P314.301 Barricades and Cordons.

Barricading or cordoning of access areas above a work area at a lower level shall be carried out as per Procedure P314.301 Barricades and Cordons.

6.2.4 Physical Barriers

Physical Barrier at the elevated work area or the lower work area – could include, but are not limited to, steel mesh, structural ply, hording, conveyor belt, insertion rubber, steel plate,

FORM NO: QA-053-0215	IF THIS DOCUMENT IS IN PRINTED FORMAT, AND NOT CONTAINED IN A CONTROLLED MANUAL, THIS IS <u>NOT</u> A CONTROLLED QUALITY SYSTEM DOCUMENT	PAGE 5 of 14
-------------------------	--	-----------------

Title: Work at Height	No: P314.311 Issue: 5 Rev: 3	Approval: (Inits)
------------------------------	--	----------------------

scaffold planks etc. Gridmesh is not a physical barrier when the size of an object, tool, equipment etc. has the potential to fall through the gridmesh.

Perimeter Containment Screening

Perimeter containment screening is used as a control measure shall be erected along each part of a structure from which an object could fall in the adjoining work area.

If the perimeter containment screening is used to redirect a falling object onto a catch platform, each screen must be fitted vertically to the top of or flush with the outer edge of the catch platform to redirect a falling object onto the catch platform.

If the perimeter containment screening is not used to redirect a falling object into a catch platform, each screen must be designed to prevent an object from falling from the level where the work is being done.

Screen must be made from mesh, timber, plywood or metal sheeting. Gaps may not exceed 25mm:

- The horizontal gap between screens immediately beside each other or a screen and framework supporting it.
- The vertical gap between a screen immediately above it or a screen and framework supporting it.

The framework supporting a screen must be able to bear the load of the screen.

Gantry / Hoarding

If a gantry / hording is used as a control measure, it shall be erected to an appropriate design that is strong enough for the circumstances in which it is used and be able to prevent an object that may hit it from entering the adjoining area.

Catch Platform

Where a catch platform is used as a control measure it shall be installed to an appropriate design that is strong enough for the circumstances in which it is used.

When a catch platform is being installed, modified or removed, control measures shall be used to prevent any component of the platform falling on any person.

6.3 Control Measures for Risk of a Person Falling

No person shall work in a position where there is potential for an un-arrested fall from a height that is likely to cause injury.

Control measures to prevent a person falling in order of priority are:

- a barricade (as per Procedure P314.301 Barricades and Cordons)
- a fall protection cover placed over an opening and secured to prevent movement
- a travel restraint system

If fall prevention control measures are not practicable, then the following control measures to arrest a fall must be implemented—

- a fall arresting platform, or
- a fall-arrest harness system

Provision shall be made for users to approach and connect onto a fall protection system without being exposed to a fall-risk situation. If there is the risk of a fall, they shall be protected by means of another fall-arrest system with provision for transferring to or from each system whilst always connected to one system or the other. The approach may comprise for example a fully protected walkway. The same requirements apply when persons are leaving the system.

FORM NO: QA-053-0215	IF THIS DOCUMENT IS IN PRINTED FORMAT, AND NOT CONTAINED IN A CONTROLLED MANUAL, THIS IS <u>NOT</u> A CONTROLLED QUALITY SYSTEM DOCUMENT	PAGE 6 of 14
-------------------------	--	-----------------

Title: Work at Height	No: P314.311 Issue: 5 Rev: 3	Approval: (Inits)
------------------------------	--	----------------------

6.3.1 Fall Protection Cover Placed Over an Opening

A fall protection cover placed over an opening must be able to withstand the impact of a fall onto it of any person and be securely fixed in place to prevent it being moved or removed accidentally and shall not be used as a working platform.

When creating the opening and installing the barricade / fall protection cover, the person shall be protected from a fall using a travel restraint system or fall arrest harness system.

All fall protection covers used as a control measure must comply with Engineering Standard – Access Guide for Access Hatches, Manways & Inspection Ports QD50-042-02

6.3.2 Travel Restraint Systems

Where a fall protection cover cannot be utilised, a travel restraint system is the preferred control measure. Where a person is required to carry out work within 2 metres of any - unprotected edge, or opening in the surface of a building or other structure where there is a potential to fall, a travel restraint system rated as full fall arrest, as a minimum, shall be used.

Where a person is required to work further than 2 metres away from an unprotected edge or an opening in the surface of a building or other structure, they shall be either restrained or protected by a barricade. For example for a tank or substation that has an access ladder to the roof and then handrails situated either side and the remainder of the roof top has unprotected edges, a travel restraint system would be required from the ladder to the area on the roof top where work is to be conducted.

Travel restraints systems shall only be installed after the approval of the Area Mechanical Engineer has been given. A full body harness shall be used and all components of the system shall be inspected prior to use.

Restraint belts shall not be used on the QAL site.

A travel restraint system **shall not** be used where there is a risk of free or restrained fall either vertically or on slopes steeper than 15° or at a lessor slope where footing cannot be safely maintained.

Aluminium and/or its alloys shall not be used for any components of a travel restraint system.

6.3.3 Fall Arresting Platforms

The use of fall arresting platforms to “catch” a person shall only be used where it has not been possible to eliminate the fall or provide a more reliable means of fall protection.

A fall arresting platform must be able to withstand the impact of a fall onto it.

6.3.4 Fall-Arrest Harness Systems

A fall arrest harness systems is the least favoured control.

Fall arrest systems shall be installed and maintained in accordance with the instructions of the manufacturer or supplier, a qualified engineer or competent person.

A harness worn for fall arrest shall be fitted with suspension trauma straps.

Supervision shall ensure a person using a fall arrest harness system **is not working alone**.

Title: Work at Height	No: P314.311 Issue: 5 Rev: 3	Approval: (Inits)
------------------------------	--	----------------------

Anchorage points shall be managed in accordance with section 6.3.6.

Each anchorage point of a system shall be located so that a lanyard of the system can be attached to it before the person using the system moves into a position where the person could fall.

The fall arrest harness shall incorporate hardware for attachment to the lanyard assembly, located in such a position that the wearer, whether conscious or unconscious, is retained in the head-up position in the event of a fall, for example – dorsal ring or extension strap.

The energy absorber of the system must limit the force applied to the person who has fallen to 6 kN.

The lanyard assembly should be as short as practicable and the working slack not more than 2.0 metres when used in conjunction with a fall-arrest harness system to minimise the pendulum effect. This 2.0 metre length is inclusive of the personal energy absorber and attachment fittings.

A lanyard assembly comprises a lanyard, which may be made from synthetic fibre rope or webbing (synthetic lanyards shall be used as per Engineering Standard – Synthetic Slings and Safety Harnesses – QM-131-02), or steel wire rope, and a personal energy absorber. The personal energy absorber may be a separate item or manufactured into the lanyard.

All synthetic lanyards and harnesses shall be used as per Engineering Standard QM-131-02 – Synthetic Slings and Safety Harnesses.

The overall length of a lanyard, including the energy absorber used to attach a backup type rope grab to a vertical safety line must not be more than 300 mm.

All components of the system shall be inspected by the user prior to every use.

The person using the fall arrest harness system must ensure that:

- no part of the system can come into any contact with anything that could affect the safe use of the system
- Should any chemical contamination occur during use, the entire device shall be washed in accordance with section 6.9.
- Aluminium and / or its alloys shall not be used for any components of a fall arrest harness system.
- If the system has been used to arrest a fall, the system must not be used again unless its manufacturer or a competent person has inspected it and decided it is fit for safe use.
- there is enough distance available for a person using the system to fall to prevent the person hitting an object, the ground or another surface

Factors to be considered are in determining the minimum required fall clearance is:

- the person's height
- the height and position of the anchorage point;
- the length of the lanyard any slack in the static line;
- any stretching of the lanyard or static line when extended by a fall;
- the length of the energy absorber when extended by a fall ;
- Residual clearance – at least 1 metre;
- any other relevant factor.

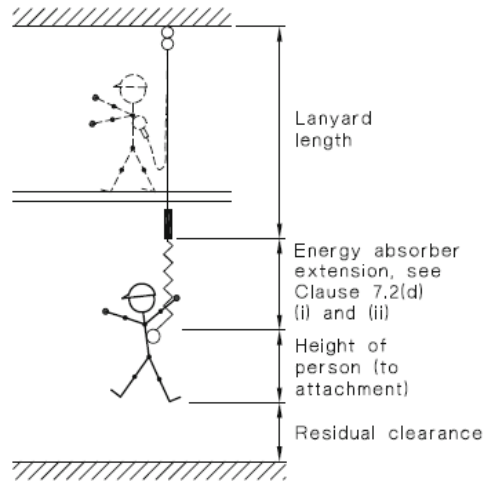

(a) Single anchor point—lanyard with energy absorber

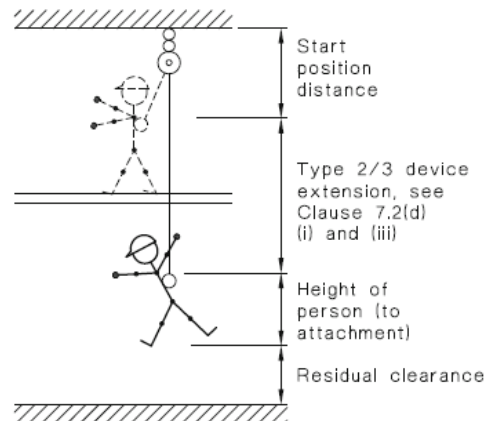

(b) Type 2/3 fall-arrest device (e.g. inertia reel)

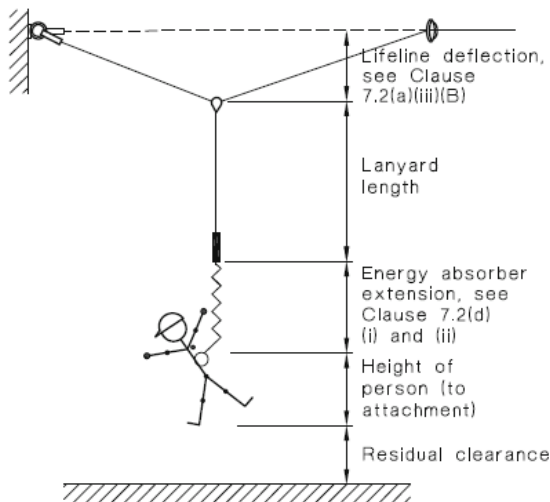

(c) Horizontal lifeline—lanyard with energy absorber

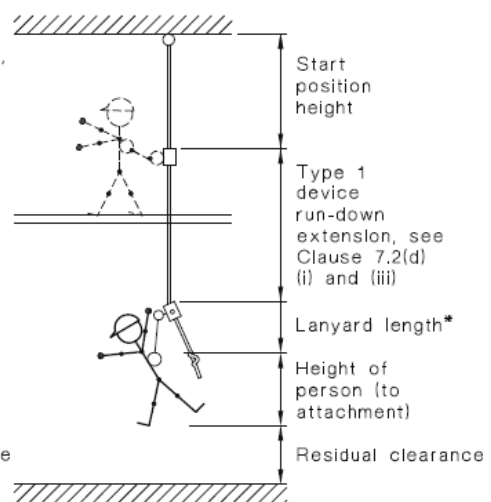

(d) Type 1 fall-arrest device on flexible line

*If an energy absorber is fitted, its extension shall be added to the lanyard length.

Effect of Lateral offset when using a fall arrest device.

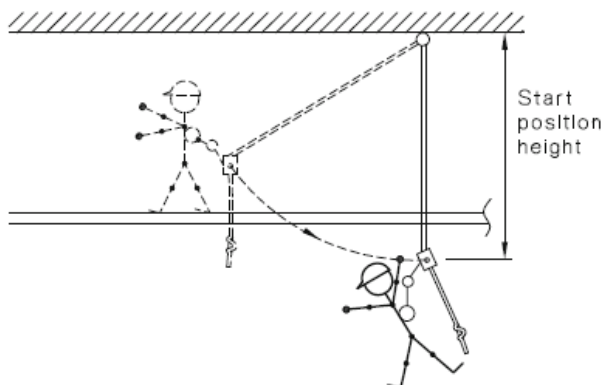

(a) Type 1 fall-arrest device

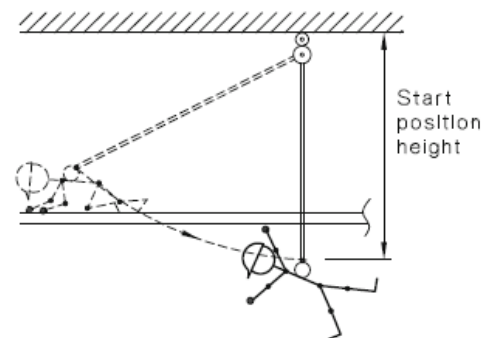

(b) Type 2/3 fall-arrest device

Title: Work at Height	No: P314.311 Issue: 5 Rev: 3	Approval: (Inits)
------------------------------	--	----------------------

6.3.5 Industrial Safety Net

Industrial safety nets shall only be used to capture objects that may fall and not be used as a control measure to capture people falling into the net.

If a risk assessment identifies an industrial safety net is required as a control measure it must be designed by a qualified engineer or competent person for the purpose for which the person intends to use it.

The Supervisor of the work area must ensure that the net is installed, used, inspected and maintained according to the instructions of the net's manufacturer, supplier, an engineer or competent person.

6.3.6 Anchorage Points

It is critical that anchorage points be selected and used only in accordance with AS1891.4:2009 Industrial Fall – Arrest Systems & Devices - Selection, Use & Maintenance. A guide to that standard is set out below. This guide is not meant to replace the Australian Standard which should be referred to in its entirety.

Each anchorage point of a fall-arrest or travel restraint system shall be:

- designed by a qualified engineer for the purpose; or
- inspected and approved by a competent person before the anchorage point is first used; and
- inspected by the user prior to each use.

Anchorage points may be selected or constructed and each anchorage point of the system, other than an anchorage point supporting a static line, must have a capacity of at least:

- Fall Restraint 6 kN (one person)
- Limited Free Fall 12 kN (one person)
- Fall Arrest 15 kN (one person)
- Fall Arrest 21 kN (two people)

No more than 2 persons may be attached to an anchorage point or static line at any time.

Permanent anchorage points shall be engineer designed, approved and labelled in accordance with AS1891.4. Signage will be provided for each anchorage point in place for longer than 1 month.

An anchorage point of a travel restraint system should be positioned to ensure that the restraint line does not allow the person wearing the system to free-fall.

Each anchorage point of a fall-arrest system shall be located so that a lanyard of the system can be attached as close as practical to vertical above the work place to reduce the pendulum effect.

Selected anchorage points may include, but not limited to the following:

- 180mm (7") 'I' steel beam
- 150mm (6") 'I' steel channel
- 150mm (6") steel pipe across a 3 meter span

Title: Work at Height	No: P314.311 Issue: 5 Rev: 3	Approval: (Inits)
------------------------------	--	----------------------

Scaffold

Quick-stage scaffolding and all tube-and-coupler scaffolding may be used as anchorage points for personal fall arrest systems when it complies with the requirements for an anchor point.

Scaffold handrails may be used anywhere along their length and are suitable for a double anchorage point.

Care must be taken when selecting a scaffold star as an anchorage point as welds on used scaffold may be weakened.

Slings

Where slings are required to be used as anchorage points (eg: around a steel beam), the following must occur:

- the angle between the sling legs must not exceed 120° in a basket hitch, **and**
- slings shall be protected around sharp edges and/or abrasion; **and**
- lanyard shall be attached by a shackle or karabiner through the eyes of the sling; and
- slings and lanyards shall not be reeved; **and**
- attaching shackles and karabiner shall be rated at 1.5 tonne minimum and have at least a double locking mechanism.

QAL Working At Heights Anchor Point Pocket Card can be used as a reference for additional information on selection of anchor points. (Attachment 7.2)

6.3.7 Static Lines and Safety Lines

Temporary and permanent static safety line systems shall only be installed after the approval of the Area Mechanical Engineer has been given and shall only be installed, used, inspected and maintained in accordance with the instructions of the manufacturer and AS1891.2 and QAL Engineering Standard QM50-137-02 - Temporary Static Safety Lines

6.4 Elevating Work Platforms

Elevating work platforms (EWP) shall be used in accordance with AS 2550.10 - Elevating Work Platforms and comply with overhead work requirements as stated in this procedure.

A fall-arrest harness shall be worn by personnel on the platform of a boom type elevating work platform and **an inertia reel** shall be secured to a suitable anchor point provided for the purpose (refer manufacturers handbook for location of anchor point). This also applies to persons working over water and during transit of the EWP.

Persons shall stand on the floor of the platform only, not on the handrails or items such as ladders, scaffolding or boxes, either placed on the platform floor or the handrails.

Supervision shall ensure that:

- any person using an EWP where a fall arrest harness system is required to be worn shall not work alone and;
- a second person fully qualified to operate that EWP shall be located away from the EWP whilst work at height is being carried out to act as a spotter in case of a fall from height or where there is risk of impingement or entrapment.

Personnel shall not enter or leave the platform when elevated except in an emergency unless **each** of the following conditions are met:

FORM NO: QA-053-0215	IF THIS DOCUMENT IS IN PRINTED FORMAT, AND NOT CONTAINED IN A CONTROLLED MANUAL, THIS IS <u>NOT</u> A CONTROLLED QUALITY SYSTEM DOCUMENT	PAGE 11 of 14
-------------------------	--	------------------

Title: Work at Height	No: P314.311 Issue: 5 Rev: 3	Approval: (Inits)
------------------------------	--	----------------------

- A risk assessment shows that this alternative means of access is safer than all other means of access **and**;
- The structural adequacy of the landing area has been established and the landing area is clear **and**;
- Where the landing is at the edge of a structure, the maximum gap between the platform and landing shall not exceed 100mm. The platform shall be secured (eg. tied) to a suitable point on the landing and access and egress shall not take place unless there is a double hook-up of the safety harness to suitable anchorage points at all times **or**;
- Where the landing is an area away from the edge of a structure, the landing point shall not be less than 2.0 metres from the edge of the structure, where any potential fall is in excess of 1.0 metre **and**;
- The base controls shall be tagged to indicate the equipment is in use and to caution against interference **and**;
- An “Authority to Enter or Exit an Elevated Work Platform when Elevated” has been authorised. Form is located in Portal/Site Document Access/Forms/Health & Safety/HSE/HSE-026.

6.5 Scissor Lift

A Scissor Lift shall be used in accordance with AS 2550.10 – Elevating Work Platforms and comply with overhead work requirements as stated in this procedure.

A fall-arrest harness with a retractable lanyard shall be worn by personnel on the platform of a scissor lift if there is a requirement to lean or reach outside the scissor lift handrails. The retractable lanyard shall be secured to a suitable anchor point provided for the purpose (refer manufacturers handbook for location of anchor point).

Persons shall stand on the floor of the platform only, not on the handrails or items such as ladders, scaffolding or boxes, either placed on the platform floor or the handrails.

Supervision shall ensure that:

- any person using an scissor lift where a fall arrest harness system is required to be worn shall not work alone **and**;
- a second person fully qualified to operate that scissor lift shall be located away from the scissor lift whilst work at height is being carried out to act as a spotter in case of a fall from height.

6.6 Workbox

Fall-arrest harnesses shall be worn by persons working from a workbox. The harness shall be anchored to the safety harness anchorage points within the box.

Personnel shall not enter or leave a workbox whilst elevated (except in an emergency) unless the box is firmly landed on a structure not less than 2m from an edge and an ‘Authority to enter or exit an elevated work platform when elevated’ (HSE-026) has been approved. Positive anchorage of a fall-arrest harness system shall be maintained.

6.7 Scaffolding

The requirements of work involving scaffolding, work platforms and suspended scaffolds are detailed in P314.402 – Scaffolding, Temporary Work Platforms and Suspended Scaffolds.

FORM NO: QA-053-0215	IF THIS DOCUMENT IS IN PRINTED FORMAT, AND NOT CONTAINED IN A CONTROLLED MANUAL, THIS IS <u>NOT</u> A CONTROLLED QUALITY SYSTEM DOCUMENT	PAGE 12 of 14
-------------------------	--	------------------

6.8 Ladders

Portable ladders shall be used in accordance with P314.401 - Portable Ladders.

6.9 Inspections

The user shall inspect all components of the fall arrest or travel restraint system (ie- harness, lanyard, energy absorber and anchorage point) before and after each use.

A competent person shall conduct a documented inspections and services as follows:

EQUIPMENT	INSPECTION INTERVAL	SERVICE
Harness	3 month (inc. Wash)	N/A
Lanyard	3 month (inc. Wash)	N/A
Anchor Points	6 month	6 month for friction anchors
Static Lines	6 month	6 month
Fall Arrest Devices (eg: Inertia Reel)	3 month	12 month
Rope and associated soft goods	3 month	N/A

A written record of inspections using the template in Portal/Site Document Access/Forms/Health & Safety/HSE/HSE-011 Fall Arrest Harness Lanyard Inspection Log, or similar, shall be kept for the life of the system or 4 years, whichever is the lessor. The item will then be tagged with the appropriate RGBY (Red, Green, Blue, Yellow) coloured cable tie for that quarter.

QAL uses two types on inspection tags:

For equipment requiring quarterly inspections - the RGBY colour code system is used to demonstrate that equipment was fit for service at the time it was last inspected. Inspection tags remain current for 3 months only.

TAG COLOUR	INSPECTION PERIOD	Sample: QAL Tag
Red	January to March	
Green	April to June	
Blue	July to September	
Yellow	October to December	

For equipment with inspection other than quarterly – a tag will be fitted and stamped with the next inspection date.

Note: The team may commence checks two weeks prior and up to 2 weeks after the expiry date, with tags changed over as equipment is identified as compliant.

If any component of the system shows evidence of wear or weakness that may affect the systems safety the defective component shall not be used. The defective component shall be removed from service and destroyed.

Synthetic components shall be washed in warm water with a mild detergent, or as recommended by the manufacturer, every 3 months or more frequently if required, and stored in a clean, cool, dry location free from direct sunlight, chemical fumes or corrosive materials.

A record of washing shall be maintained.

6.10 Approval of Alternative Methods

Alternative methods for work at height include, but is not limited to, bosuns chair, swing stages and industrial rope access. If these methods are to be used they must meet the requirements of the WH&S Legislation and relevant Australian standards.

Title: Work at Height	No: P314.311 Issue: 5 Rev: 3	Approval: (Inits)
------------------------------	--	----------------------

A documented risk assessment shall be conducted by the person proposing the method and the method shall be approved by the Health Safety & Security Superintendent.

6.11 Training

All persons using, installing and maintaining personal fall protection systems shall have completed Nationally Accredited Work Safety at Height with course codes RIIWHS204D, RIIOHS204A, MNMG237A, CPCCCM2010A or CPCCCM1006A.

It is mandatory for people to attend SM145 Training before commencing elevated work.

6.12 Records

A register of all permanent anchorage points and static and safety lines shall be maintained by the Engineering & Asset Integrity Superintendent in SAP.

Training records shall be recorded in SAP against the individual by supervision.

A written record of inspections shall be kept by the Superintendent or Contractor Principal in relevant offices for 4 years or the life of the harness system, whichever is the lesser.

The Risk Assessment and Rescue Plan shall be kept on the job

7.0 ATTACHMENTS

- 7.1 Flow Chart
- 7.2 QAL Working at Height Anchor Point Pocket Card

Working at Heights – Decision Making Guide

Procedures – P314.311 Work at Height & P314.301 Barricades and Cordons

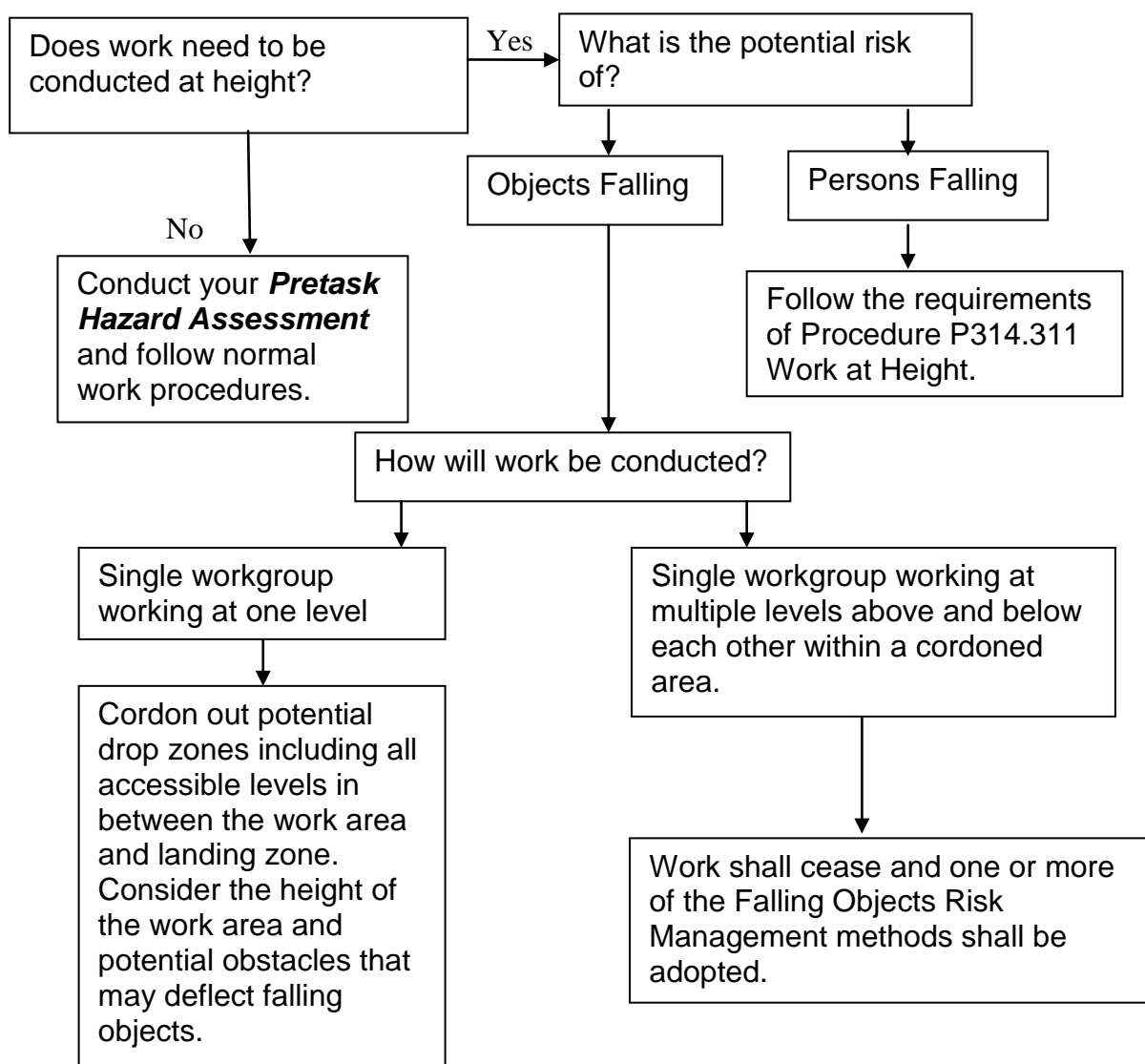







Falling Objects Risk Management Methods to control risks:

- **Time** eg, have each workgroup work in their work area at a different time to eliminate the risk.
- **Distance** eg, move the workgroups apart sufficiently to be out of each other's fall zone as demarcated by the cordoned area.
- **Physical Barrier** eg, encapsulates the work area to prevent objects falling from the work area or install a hording.

If there are any issues relating to Work at Heights or Barricades and Cordons contact the relevant Safety Group Representative for your area or contract.



QAL Working At Heights Anchor Point Pocket Card

Fall Arrest Minimum Member Size			
Member Type	Min Size mm	Min Size in	Max Span m
Standard UB 	150	6 x 3	3
	180	7 x 3.5	4
	200	8 x 5.25	5
	250	10 x 5.75	7
	310	12 x 6.5	8
Standard UC 	100	4 x 4	2.5
	150	6 x 6	4
	200	8 x 8	6
Parallel Flange Channel 	150	6 x 3	3
	180	7 x 3	4
	200	8 x 3	5
	250	10 x 3.5	6
	300	12 x 3.5	8
Equal Angle 	100 x 12	4 x ½	3
	125 x 12	5 x ½	4
	125 x 16	5 x 5/8	5
	150 x 12	6 x ½	6
	150 x 16	6 x 5/8	8
Unequal Angle 	125 x 75 x 10	5 x 3 x 3/8	3
	150 x 90 x 12	6 x 3.5 x ½	4
Steel Pipe 	150 NB	6	3
	200 NB	8	4
	250 NB	10	5
	300 NB	12	6
	350 NB	14	7
	400 NB	16	8
	450 NB	18	9
	500 NB	20	9.7

A rescue plan must be in place.

WHAT TO LOOK FOR

1. This card is to be used by a competent person to complete a sensible set up
2. This card is used to confirm the basic member design info
3. The competent person must check the adequacy of the structure supporting the fall arrest members
4. The competent person then checks the set up prior to each subsequent use

A competent person is a Rigger or Certified Engineer

These values are guidelines only and are intended for a maximum of one person per beam.

Refer to QAL Work At Height Procedure P314.311 for details.

A fall arrest beam must have as a minimum a 6mm CFW or 2 x M20 Gr8.8 bolts at each end.

Visually inspect beams and all connections for cracks, corrosion, porosity and distortion prior to use.

Check that there is no significant loading being supported by the fall arrest beams span.

Members are to be horizontal if supporting off mid span, diagonal members shall only be used at the lower end.

Hollow sections are not to be used.

Qualified personnel are required to install fall arrest equipment to fall arrest beams and horizontal life rails.

Beams shall be orientated in their strong axis.

If in doubt, or for more information contact Engineering.